

LRVTI 51 M 1000 P3K-TSSL

Laser Retroreflective Sensor

- Teach function
- Collimated red light laser
- Small laser spot and small reflector
- Polarized filter
- High operating frequency
- Robust metal casing
- Bright LED, Connector M8 with ring LED
- Functional reserve indicator/contamination indicator
- Light/dark switching



Safety instructions

Inproper use may result in hazardous radiation exposure. Pay attention to accident prevention rules and laser class. The instruments are not to be used for safety applications, in particular applications in which safety of persons depends on proper operation of the instruments. These instruments shall exclusively be used by qualified personnel.

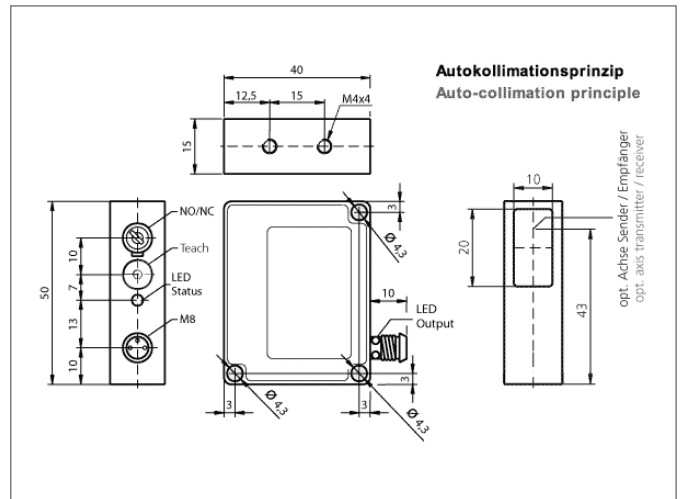

TECHNICAL INFORMATION (typ.)		+20°C, 24V DC
Operating principle		Retroreflective sensor
Evaluation		digital
Size		50 x 40 x 15 mm (Dimensions)
Design		cuboid design
Emitted light		Red light laser, 650 nm, clocked
Laser class		1 (IEC 60825-1)
Operating distance		1.000 mm
Service voltage		10 ... 35 V DC
Internal power consumption		< 40 mA
Resolution		Ø 0,2 mm
Sensitivity adjustment		Teach key
Referring reflector		RL 13 x 17 mm, (included)
Switching output		pnp, 200 mA, NO/NC, switchable
Switching hysteresis		< 0,1 mm
Voltage drop		< 2,8 V
Switching frequency		2.000 Hz
Reproducibility		0,05 mm
Ambient temperature		0 ... +50 °C
Ambient light immunity		5 kLx
Insulation voltage endurance		500 V
Protection class		IP 67
Protection degree		III, operation on protective low voltage
Casing material		Die-cast zinc black lacquered finish

LRVTI 51 M 1000 P3K-TSSL

Laser Retroreflective Sensor



TECHNICAL INFORMATION (typ.)		+20°C, 24V DC
Material		polymethyl methacrylate (Window)
Connection		Connector, M8, 3-poled
Connecting cable		TK ...